

2A 650V N Channel MOSFET

Features

- $V_{DS} = 650V$
- $I_D = 2A @V_{GS} = 10V$
- $R_{DS(ON)} (Typ) = 4.3\Omega @V_{GS} = 10V$

Applications

- Power Supply
- PFC
- High Current, High Speed Switching

Descriptions

These N-channel MOSFET are produced using advanced plane MOSFET Technology, which provides Low on-state resistance, high switching performance and excellent quality.

These devices are suitable device for SMPS, high Speed switching and general purpose applications.

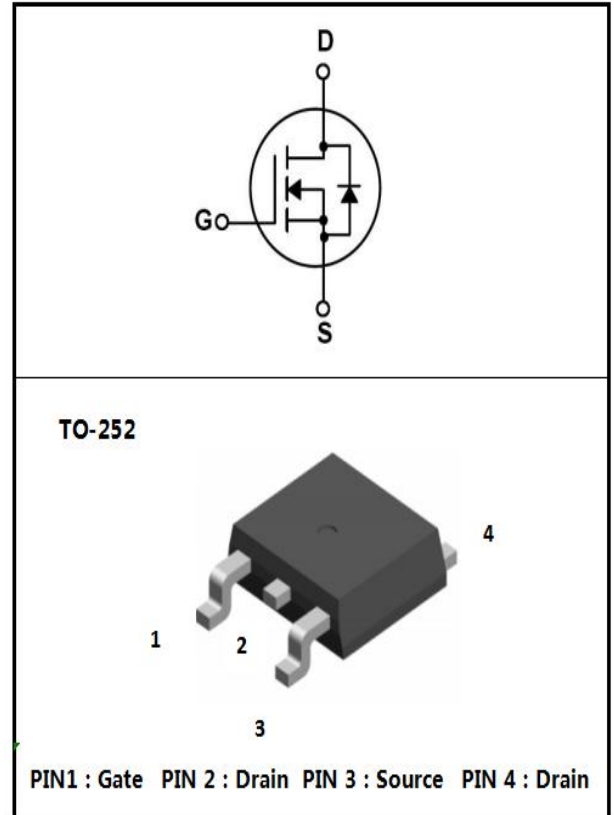

Absolute Maximum Ratings(Ta=25°C)

Parameter	Symbol	Rating	Unit
Drain-Source Voltage	V_{DS}	650	V
Drain Current	$I_D(T_C=25^\circ\text{C})$	2.0	A
Drain Current	$I_D(T_C=100^\circ\text{C})$	1.3	A
Drain Current - Pulsed	I_{DM}	8	A
Gate-Source Voltage	V_{GS}	± 30	V
Single Pulsed Avalanche Energy	E_{AS}	120	mJ
Repetitive Avalanche Energy	E_{AR}	5.4	mJ
Avalanche Current	I_{AR}	2.0	A
Power Dissipation	$P_D(T_C=25^\circ\text{C})$	28	W
Operating and Storage Temperature Range	T_J, T_{STG}	-55 to 150	$^\circ\text{C}$
Junction to Ambient	$R_{\theta JA}$	110	$^\circ\text{C/W}$
Junction to Case	$R_{\theta JC}$	4.46	$^\circ\text{C/W}$

Electrical Characteristics(Ta=25°C)

Parameter	Symbol	Test Conditions	Min	Typ	Max	Unit	
Drain-Source Breakdown Voltage	BV_{DSS}	$V_{GS}=0V$ $I_D=250\mu A$	650			V	
Zero Gate Voltage Drain Current	I_{DSS}	$V_{DS}=650V$ $V_{GS}=0V$			1.0	μA	
		$V_{DS}=480V$ $T_C=125^\circ\text{C}$			100	μA	
Gate-Body Leakage Current Forward	I_{GSS}	$V_{GS}=\pm 30V$ $V_{DS}=0V$			± 0.1	μA	
Gate Threshold Voltage	$V_{GS(th)}$	$V_{DS}=V_{GS}$ $I_D=250\mu A$	2.0		4.0	V	
Static Drain-Source On-Resistance	$R_{DS(on)}$	$V_{GS}=10V$ $I_D=1.0A$		4.3	6.5	Ω	
Input Capacitance	C_{iss}	$V_{DS}=25V$ $V_{GS}=0V$ $f=1.0\text{MHz}$		325		pF	
Output Capacitance	C_{oss}				30		pF
Reverse Transfer Capacitance	C_{rss}				5		pF
Total Gate Charge	Q_G	$V_{DS}=520V, I_D=2.0A,$ $V_{GS}=10V$		46		nC	
Gate-Source Charge	Q_{GS}			4.2			
Gate-Drain Charge	Q_{GD}			8.5			

Electrical Characteristics(Ta=25°C)

Parameter	Symbol	Test Conditions	Min	Typ	Max	Unit
Turn-On Delay Time	$t_{d(on)}$	$V_{DD}=325V$ $I_D=2.0A$ $R_G=25\Omega$		36		ns
Turn-On Rise Time	t_r			42		
Turn-Off Delay Time	$t_{d(off)}$			132		
Turn-Off Fall Time	t_f			41		
Maximum Continuous Drain-Source Diode Forward Current	I_S				2.0	A
Maximum Pulsed Drain-Source Diode Forward Current	I_{SM}				8	A
Drain-Source Diode Forward Voltage	V_{SD}	$V_{GS} = 0V$, $I_S = 2.0A$			1.4	V
Reverse Recovery Time	t_{rr}	$V_{GS} = 0V$, $I_S = 2.0A$, $di_F/dt = 100 A/\mu s$		182		nS
Reverse Recovery Charge	Q_{rr}			0.8		nC

Electrical Characteristic Curve

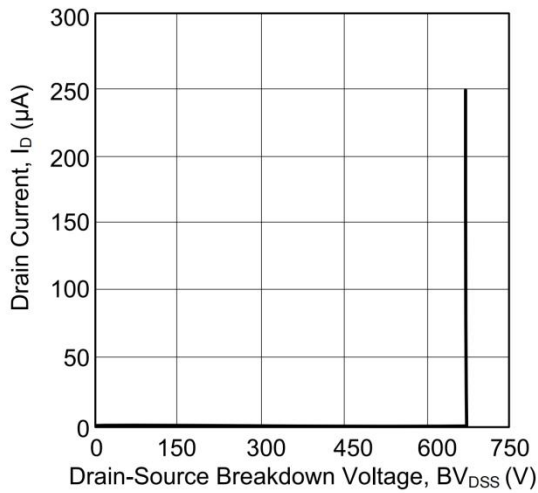

1. Drain Current vs. Drain-Source Breakdown Voltage

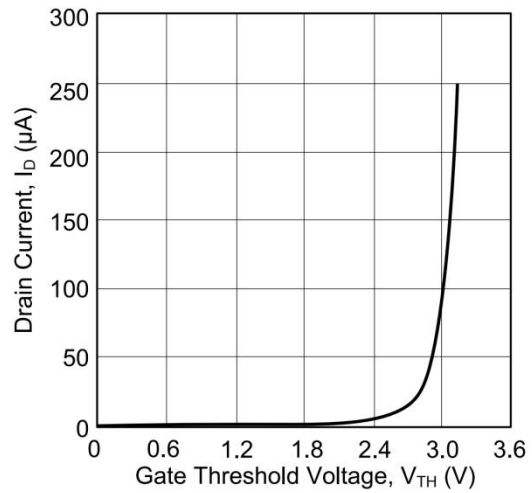

2. Drain Current vs. Gate Threshold Voltage

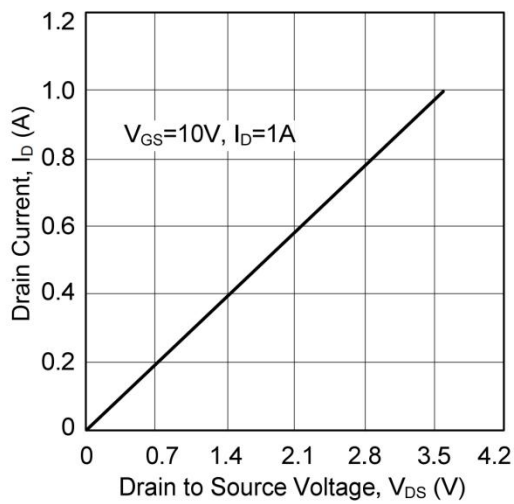

3. Drain-Source On-State Resistance Characteristics

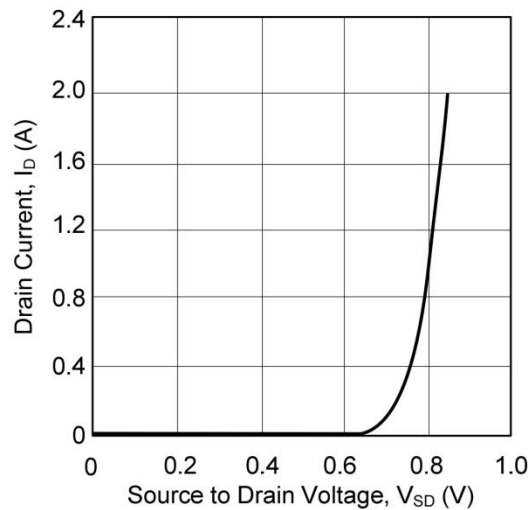

4. Drain Current vs. Source to Drain Voltage

Marking Instructions

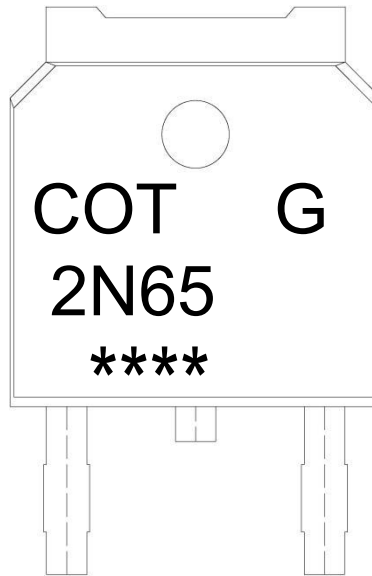

Note:

- COT: Company Logo
- G: Halogen Free
- 2N65: Product Type.
- ****: Lot No. Code, code change with Lot No.

Packaging SPEC.

REEL INFORMATION

Package Type	Units					Dimension		
	Units/Reel	Reels/Inner Box	Units/Inner Box	Inner Boxes/Outer Box	Units/Outer Box	Reel unit: mm	Inner Box unit: mm ³	Outer Box unit: mm ³
TO-252	2,500	2	5,000	5	25,000	13" ×16	360×360×50	385×257×392

TUBE INFORMATION

Package Type	Units					Dimension		
	Units/Tube	Tubes/Inner Box	Units/Inner Box	Inner Boxes/Outer Box	Units/Outer Box	Tube unit: mm ³	Inner Box unit: mm ³	Outer Box unit: mm ³
TO-252	75	48	3,600	5	18,000	526×20.5×5.25	555×164×50	575×290×180

Package Outline Dimensions

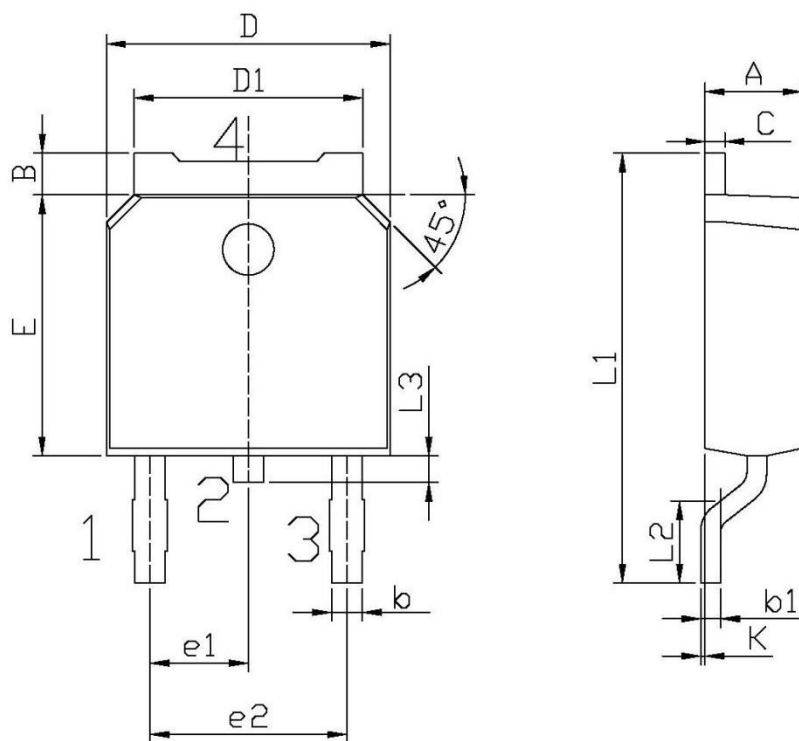

单位: mm

Symbol	Dimensions In Millimeters		Symbol	Dimensions In Millimeters	
	Min	Max		Min	Max
A	2.20	2.40	E	5.95	6.25
B	0.95	1.25	e1	2.24	2.34
b	0.70	0.90	e2	4.43	4.73
b1	0.45	0.55	L1	9.85	10.35
C	0.45	0.55	L2	1.70	2.00
D	6.45	6.75	L3	0.60	0.90
D1	5.10	5.50	K	0.00	0.10

TO-252